

# Catifa 46 / 4 Legs

## Design by Lievore Altherr Molina, 2004

Art. 0251: 4 leg base and polypropylene shell

Art. 0254: 4 leg base and polypropylene shell with armrests

Stackable chair with four-leg base frame brushed in chromed painted steel or brushed stainless steel. The shell is available in single-color and bi-color polypropylene or upholstered in two grades of hard leather. Versions with polypropylene shell and painted or brushed stainless steel base can be used outdoor. Polypropylene and steel armrests, are available upon request.



*clip.it.easy*

### Dimensions\*

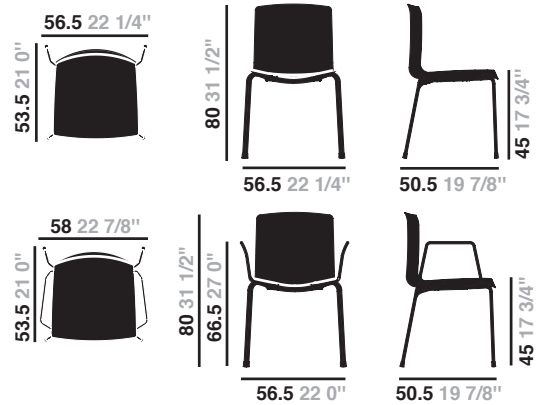

\* Files CAD 2D - 3D available for download at [www.arper.com](http://www.arper.com)

### Shipment details

Art.	kg	m <sup>3</sup>	lb	ft <sup>3</sup>
Art. 0251				
1 PCS = 2 boxes	7.9	0.243	17.38	8.581
4 PCS = 2 boxes	28	0.304	61.6	10.735
Art. 0254				
1 PCS = 3 boxes	10.2	0.271	22.44	9.570
4 PCS = 3 boxes	35.7	0.340	41.7	12.006

### Base finishes

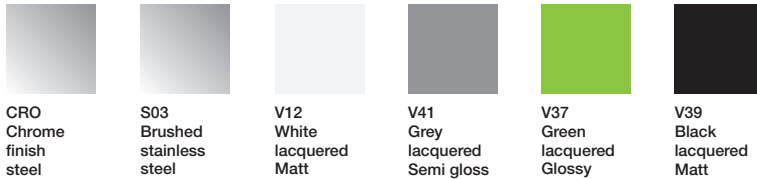

### Materials

#### Polypropylene



PO  
Polypropylene  
one color  
10 colors

PO  
Polypropylene  
two colors  
10 colors



Outdoor use only for PO + S03, V12, V41, V37, V39

#### Carded In Hard leather



CU  
Hard leather  
grade 1  
4 colors

CT  
Hard leather  
grade 2  
13 colors

### Stacking options

Art. 0251 with stacking glide

PO: up to 10 pcs. - CU and CT: up to 5 pcs.

PO: up to 20 pcs. - CU and CT: up to 5 pcs.

# Catifa 46 / 4 Legs

## Design by Lievore Altherr Molina, 2004

Art. 0253: 4 leg base and upholstered shell

Art. 0253BV: 4 leg base and upholstered shell with armrests

Stackable chair with four-leg steel frame, available in chromed, brushed or painted version. The shell is available upholstered in leather, faux leather, fabric or customer's fabric. Available with steel armrests, also upholstered.



clip.it.easy®

### Dimensions\*

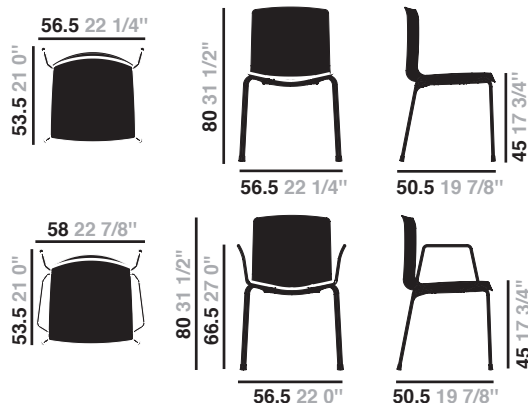

\* Files CAD 2D - 3D available for download at [www.arper.com](http://www.arper.com)

### Shipment details

Art. 0253	kg	m <sup>3</sup>	lb	ft <sup>3</sup>
1 PCS = 2 boxes	9.2	0.265	20.24	9.358
4 PCS = 2 boxes	34	0.360	74.8	12.713
Art. 0253BV				
1 PCS = 3 boxes	11.5	0.293	25.3	10.347
4 PCS = 3 boxes	41.7	0.396	91.74	13.984

### Base finishes



### Stacking options

Art. 0253 with stacking glide  
 FABRIC: up to 8 pcs. - LEATHER: up to 5 pcs.  
 FABRIC: up to 8 pcs. - LEATHER: up to 5 pcs.

### Materials

#### Carded In Fabrics kvadrat and No Stain

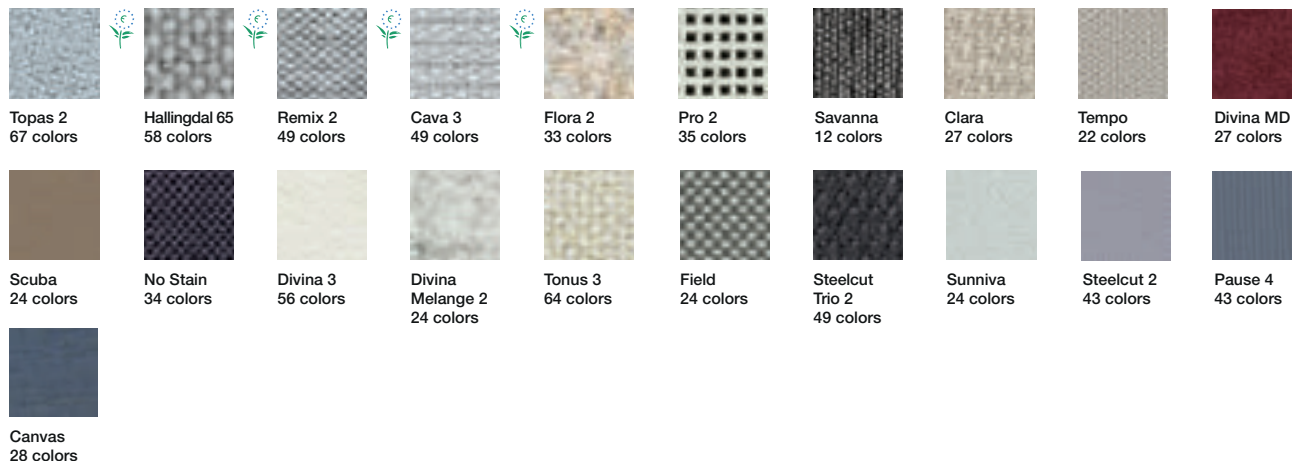

#### Carded In Faux leather, Soft leather and chrome free leather by elmo.

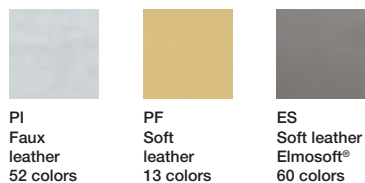

# Catifa 46 / 4 Legs

## Design by Lievore Altherr Molina, 2004

---

Graded In Fabrics by

**kvadrat**

[www.kvadrat.dk](http://www.kvadrat.dk)

**camira**

[www.camirafabrics.com](http://www.camirafabrics.com)



[www.fidivi.com](http://www.fidivi.com)

**Gabriel**

[www.gabriel.dk](http://www.gabriel.dk)



[www.spradling.eu](http://www.spradling.eu)

 **climatex**®

[www.climatex.com](http://www.climatex.com)

**Serge Ferrari**

[www.en.sergeferrari.com](http://www.en.sergeferrari.com)



[www.en.sergeferrari.com](http://www.en.sergeferrari.com)

**DESIGN  
TEX**

[www.designtex.com](http://www.designtex.com)

**maharam**

[www.maharam.com](http://www.maharam.com)

Visit the company website [www.arper.com](http://www.arper.com) to view the available fabrics and swatches.

# Catifa 46 / 4 Legs

## Design by Lievore Altherr Molina, 2004

Art. 0310: 4 leg base and shell with upholstered cover

Art. 0310BV: 4 leg base and shell with upholstered cover and with armrests

Stackable chair with four-leg steel frame, available in chromed, brushed or painted version. The shell is upholstered with a removable non-washable cover in leather, faux leather, fabric or customer's fabric. Available with steel armrests, also upholstered.



*clip.it.easy*

### Dimensions\*

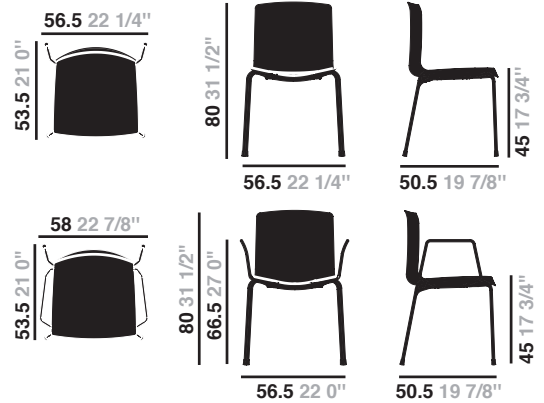

\* Files CAD 2D - 3D available for download at [www.arper.com](http://www.arper.com)

### Shipment details

	kg	m <sup>3</sup>	lb	ft <sup>3</sup>
Art. 0310				
1 PCS = 2 boxes	9.2	0.265	20.24	9.358
4 PCS = 2 boxes	34	0.360	74.8	12.713
Art. 0310BV				
1 PCS = 3 boxes	11.5	0.293	25.3	10.347
4 PCS = 3 boxes	41.7	0.396	91.74	13.984

### Base finishes



### Materials

#### Carded In Fabrics kvadrat and No Stain

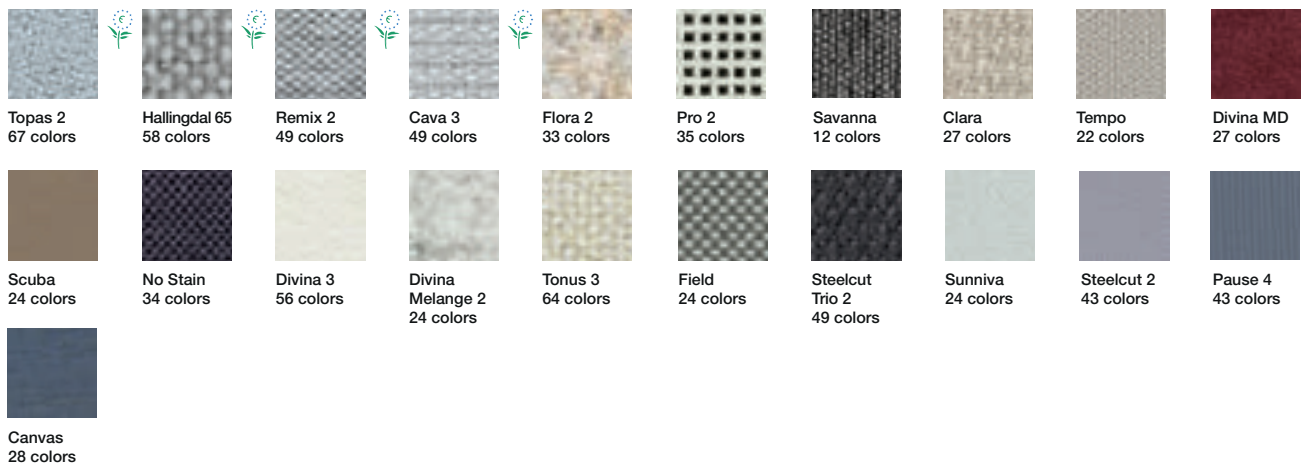

#### Carded In Faux leather, Soft leather and chrome free leather by elmo.

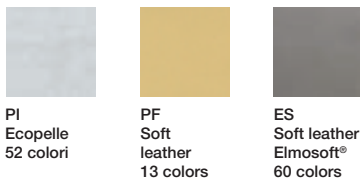

# Catifa 46 / 4 Legs

## Design by Lievore Altherr Molina, 2004

---

Graded In Fabrics by

**kvadrat**

[www.kvadrat.dk](http://www.kvadrat.dk)

**camira**

[www.camirafabrics.com](http://www.camirafabrics.com)



[www.fidivi.com](http://www.fidivi.com)

**Gabriel**

[www.gabriel.dk](http://www.gabriel.dk)



[www.spradling.eu](http://www.spradling.eu)

 **climatex**®

[www.climatex.com](http://www.climatex.com)

**Serge Ferrari**

[www.en.sergeferrari.com](http://www.en.sergeferrari.com)



[www.en.sergeferrari.com](http://www.en.sergeferrari.com)

**DESIGN  
TEX**

[www.designtex.com](http://www.designtex.com)

**maharam**

[www.maharam.com](http://www.maharam.com)

Visit the company website [www.arper.com](http://www.arper.com) to view the available fabrics and swatches.

# Catifa 46 / 4 Legs

## Design by Lievore Altherr Molina, 20

Art. 0351: 4 leg base and wood shell

Art. 0351BV: 4 leg base and wood shell with armrests

Stackable chair with four-leg base frame, available in chromed or painted steel and brushed stainless steel. The shell is available in wood, three finishes (natural oak, bleached oak, wengé). Optional steel armrests are available upon request.



*clip.it.easy*

### Dimensions\*

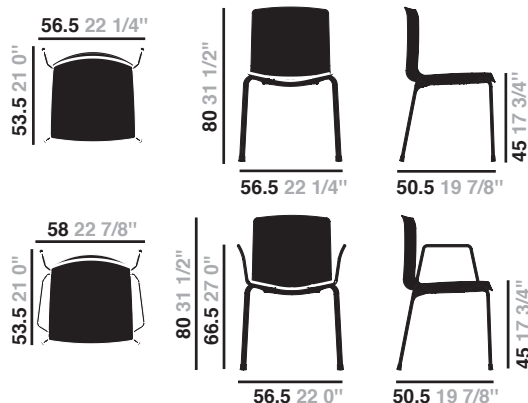

\* Files CAD 2D - 3D available for download at [www.arper.com](http://www.arper.com)

### Shipment details

Art. 0351	kg	m <sup>3</sup>	lb	ft <sup>3</sup>
1 PCS = 2 boxes	7.38	0.241	16.23	8.510
4 PCS = 2 boxes	25.9	0.316	56.98	11.159
Art. 0351BV				
1 PCS = 3 boxes	9.68	0.269	21.29	9.499
4 PCS = 3 boxes	33.6	0.352	73.92	12.430

### Base finishes



CRO  
Chrome  
finish  
steel



S03  
Brushed  
stainless  
steel



V12  
White  
lacquered  
Matt



V41  
Grey  
lacquered  
Semi gloss



V37  
Green  
lacquered  
Glossy



V39  
Black  
lacquered  
Matt

### Stacking options

Art. 0351 with stacking glide

Up to 10 pcs.

Up to 10 pcs.

### Materials

#### Wood



L  
Wood  
3 colors

# Catifa 46 / 4 Legs

## Design by Lievore Altherr Molina, 2004

Art. 0458: 4 leg base and front-face upholstered shell  
 Art. 0458BV: 4 leg base and front-face upholstered shell with armrests

Stackable chair with four-leg base frame, available in chromed or painted steel and brushed stainless steel. The shell is available in polypropylene with front-face upholstery in leather, faux leather, fabric or customer's fabric. Available with steel armrests, also upholstered.



*clip.it.easy*

### Dimensions\*

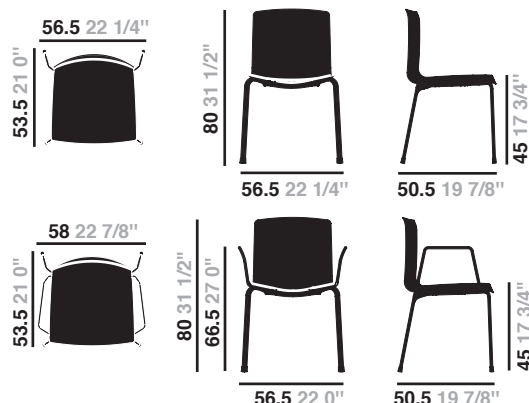

\* Files CAD 2D - 3D available for download at [www.arper.com](http://www.arper.com)

### Shipment details

Art. 0458	kg	m <sup>3</sup>	lb	ft <sup>3</sup>
1 PCS = 2 boxes	10.6	0.272	23.32	9.605
4 PCS = 2 boxes	35.4	0.368	77.968	12.995
Art. 0458BV				
1 PCS = 3 boxes	12.90	0.300	28.38	10.594
4 PCS = 3 boxes	43.12	0.404	94.864	14.267

### Base finishes



### Materials

#### Polypropylene



PO  
Polypropylene  
10 colors

#### Carded In Fabrics **kvadrat** and **No Stain**

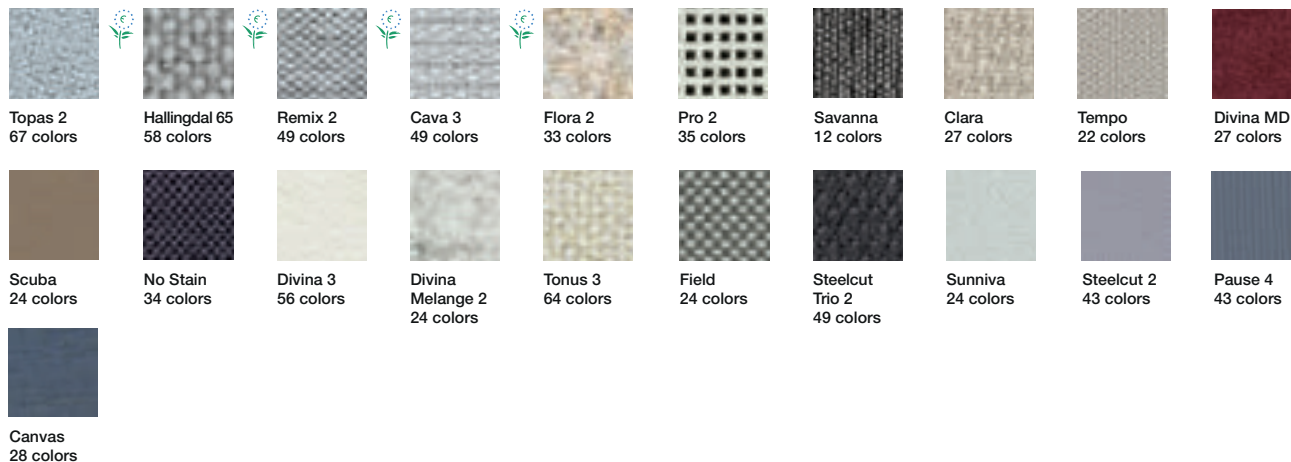

# Catifa 46 / 4 Legs

## Design by Lievore Altherr Molina, 2004

---

Carded In Faux leather, Soft leather and Chrome Free leather **elmo**.



PI  
Faux  
leather  
52 colors



PF  
Soft  
leather  
13 colors



ES  
Soft leather  
Elmosoft®  
60 colors

---

Graded In Fabrics by

**kvadrat**

[www.kvadrat.dk](http://www.kvadrat.dk)

**camira**

[www.camirafabrics.com](http://www.camirafabrics.com)



[www.fidivi.com](http://www.fidivi.com)

**Gabriel**

[www.gabriel.dk](http://www.gabriel.dk)



[www.spradling.eu](http://www.spradling.eu)

 **climatex**®

[www.climatex.com](http://www.climatex.com)

**Serge Ferrari**

[www.en.sergeferrari.com](http://www.en.sergeferrari.com)



[www.en.sergeferrari.com](http://www.en.sergeferrari.com)

**DESIGN  
TEX**

[www.designtex.com](http://www.designtex.com)

**maharam**

[www.maharam.com](http://www.maharam.com)

Visit the company website [www.arper.com](http://www.arper.com) to view the available fabrics and swatches.

arper

F +39 0422 791800

T +39 0422 7918

[www.arper.com](http://www.arper.com)



# Catifa 46 / 4 Legs

## Design by Lievore Altherr Molina, 2004

Art. 0458: 4 leg base and seat surface upholstered  
 Art. 0458BV: 4 leg base and seat surface upholstered  
 and with armrests

Stackable chair with four-leg steel frame, available in chromed or painted steel and brushed stainless steel. The shell is available in polypropylene with cushion upholstered in leather, faux leather, fabric or customer's fabric applied to the seat surface. Available with steel armrests, also upholstered.



*clip.it.easy*

### Dimensions\*

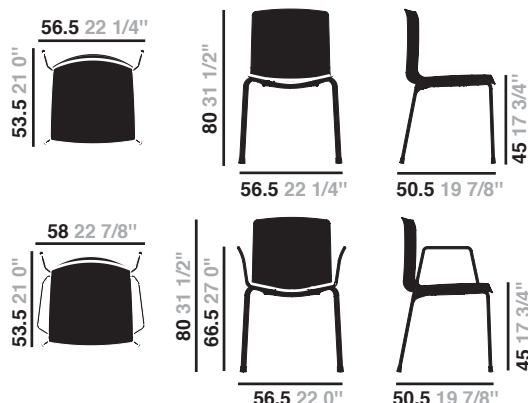

\* Files CAD 2D - 3D available for download at [www.arper.com](http://www.arper.com)

### Shipment details

Art. 0458	kg	m <sup>3</sup>	lb	ft <sup>3</sup>
1 PCS = 2 boxes	7.9	0.243	17.38	8.581
4 PCS = 2 boxes	28	0.304	61.6	10.735
Art. 0458BV				
1 PCS = 3 boxes	12.90	0.300	28.38	10.594
4 PCS = 3 boxes	43.12	0.404	94.864	14.267

### Base finishes



### Materials

#### Polypropylene



### Stacking options

Art. 0458 with stacking glide  
 FABRIC: up to 8 pcs. - LEATHER: up to 5 pcs.  
 FABRIC: up to 8 pcs. - LEATHER: up to 5 pcs.

### Carded In Fabrics **kvadrat** and **No Stain**

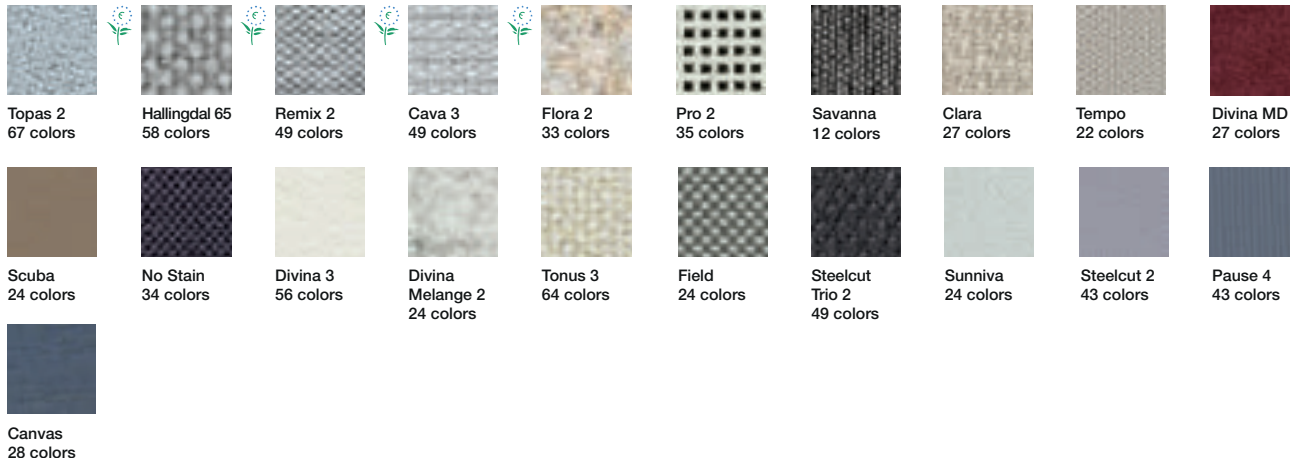

# Catifa 46 / 4 Legs

## Design by Lievore Altherr Molina, 2004

---

Carded In Faux leather, Soft leather and Chrome Free leather **elmo**.



PI  
Faux  
leather  
52 colors



PF  
Soft  
leather  
13 colors



ES  
Soft leather  
Elmosoft®  
60 colors

---

Graded In Fabrics by

**kvadrat**

[www.kvadrat.dk](http://www.kvadrat.dk)

**camira**

[www.camirafabrics.com](http://www.camirafabrics.com)



[www.fidivi.com](http://www.fidivi.com)

**Gabriel**

[www.gabriel.dk](http://www.gabriel.dk)



[www.spradling.eu](http://www.spradling.eu)

 **climatex**®

[www.climatex.com](http://www.climatex.com)

**Serge Ferrari**

[www.en.sergeferrari.com](http://www.en.sergeferrari.com)



[www.en.sergeferrari.com](http://www.en.sergeferrari.com)

**DESIGN  
TEX**

[www.designtex.com](http://www.designtex.com)

**maharam**

[www.maharam.com](http://www.maharam.com)

Visit the company website [www.arper.com](http://www.arper.com) to view the available fabrics and swatches.

**arper**

F +39 0422 791800

T +39 0422 7918

[www.arper.com](http://www.arper.com)

# Catifa 46 / 4 Legs

## Design by Lievore Altherr Molina, 2014

Art. 0325 4 leg base, wood shell and front-face upholstery  
 Art. 0325BV: 4 leg base, wood shell and front-face upholstery with armrests

Chair with four-leg steel frame, available in chromed steel, stainless steel or powdercoated version. Wood shell with front upholstery in leather, faux leather, fabric or customer's own material. Steel armrests, also upholstered, are available upon request.



### Dimensions\*

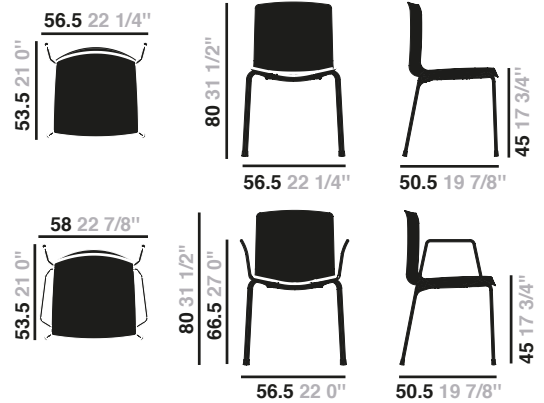

\* Files CAD 2D - 3D available for download at [www.arper.com](http://www.arper.com)

### Shipment details

Art. 0325	kg	m <sup>3</sup>	lb	ft <sup>3</sup>
1 PCS = 2 boxes	10.6	0.272	23.32	9.605
4 PCS = 2 boxes	35.44	0.368	77.968	12.995

*clip.it.easy*

### Base finishes



### Stacking options

Art. 0325 with stacking glide  
 FABRIC: up to 8 pcs. - LEATHER: up to 5 pcs.  
 FABRIC: up to 8 pcs. - LEATHER: up to 5 pcs.

### Materials

#### Wood



L  
Wood  
3 colors

#### Carded In Fabrics kvadrat and No Stain

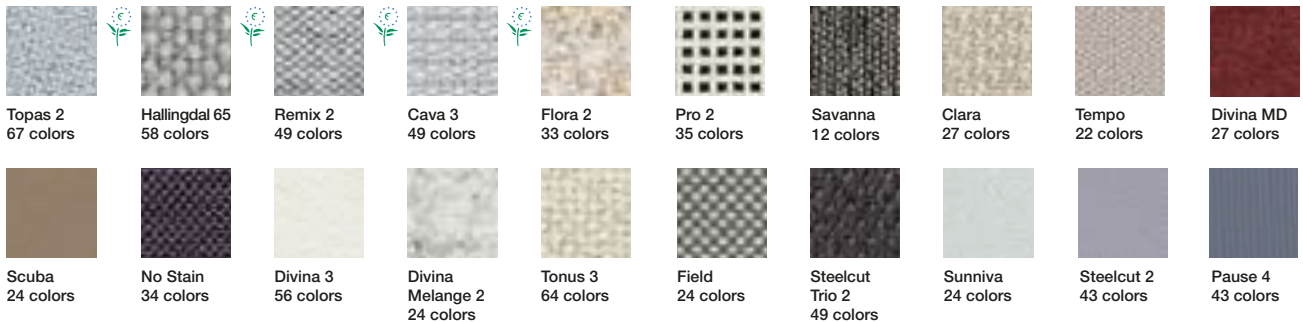

Canvas  
28 colors

# Catifa 46 / 4 Legs

## Design by Lievore Altherr Molina, 2014

---

Graded In Fabrics by

**kvadrat**

[www.kvadrat.dk](http://www.kvadrat.dk)

**camira**

[www.camirafabrics.com](http://www.camirafabrics.com)



[www.fidivi.com](http://www.fidivi.com)

**Gabriel**

[www.gabriel.dk](http://www.gabriel.dk)



[www.spradling.eu](http://www.spradling.eu)

 **climatex**®

[www.climatex.com](http://www.climatex.com)

**Serge Ferrari**

[www.en.sergeferrari.com](http://www.en.sergeferrari.com)



[www.en.sergeferrari.com](http://www.en.sergeferrari.com)

**DESIGN  
TEX**

[www.designtex.com](http://www.designtex.com)

**maharam**

[www.maharam.com](http://www.maharam.com)

Visit the company website [www.arper.com](http://www.arper.com) to view the available fabrics and swatches.

# Catifa 46 / 4 Legs

## Design by Lievore Altherr Molina, 2004

### Options and accessories



1



2



3



4

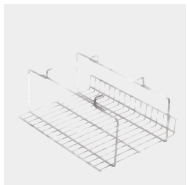

5



6



7



8



9



10



11



12



13



14



15



16



17



18

- |  |                                     |
|--|-------------------------------------|
| 1 Armrest with polypropylene one color pad | 10 Stackability                     |
| 2 Armrest with upholstery pad              | 11 Stacking protection pad          |
| 3 Cushion                                  | 12 Stacking protection pad and link |
| 4 Set of glides                            | 13 Stacking protection pad          |
| 5 Basket                                   | 14 Stacking protection pad and link |
| 6 Mobile Link                              | 15 Cover 1                          |
| 7 Mobile Link                              | 16 Cover 2                          |
| 8 Stacking glides                          | 17 Cover 3                          |
| 9 Trolley                                  | 18 Cover 4                          |

# Catifa 46 / 4 Legs

## Design by Lievore Altherr Molina, 2004

### Fire retardant test

**POLYPROPYLENE FIRE RETARDANT:**  
 - color PO101  
 - colors PO102, PO103, PO106 qty. min. 300 pcs.

**UK DOMESTIC:**  
 BS5852-1 Sch.5 Part1: Hard leather grade 1 and 2.  
 BS5852/90 Sez.5 cigarette match: Polypropylene



### Resistance test

Art.0251 and 0251BV

**CHROMED/PAINTED:**  
 ANSI-BIFMA X5.1-2002 11  
 ANSI-BIFMA X5.1-2002 16  
 ANSI-BIFMA X5.1-2002 6

EN 1022/05  
 EN 1728/2000 - EN 15373:2007 6.2.1 3°  
 EN 1728/2000 - EN 15373:2007 6.2.2 3°  
 EN 1728/2000 - EN 15373:2007 6.7 3°  
 EN 1728/2000 - EN 15373:2007 6.12 3°  
 EN 1728/2000 - EN 15373:2007 6.15 3°  
 EN 1728/2000 - EN 15373:2007 6.16 3°

**INOX:**  
 EN 1728/2000 - EN 15373:2007 6.2.1 3°  
 EN 1728/2000 - EN 15373:2007 6.2.2 3°  
 EN 1728/2000 - EN 15373:2007 6.7 3°  
 EN 1728/2000 - EN 15373:2007 6.8 3°

**UK CONTRACT:**  
 BS7176-07 Medium Hazard: Fabric (Flora 2, Pro, Tonus 3, Topas 2, Hallingdal 65). Elmosoft, Faux leather. BS7176-07 Low Hazard: Soft leather. Faux leather. Fabric (Orange 2, Divina 3, Divina Melange 2).

**UK DOMESTIC:**  
 BS5852-1 Sch.4-5 Part1: Faux leather. Soft leather, Elmosoft. Fabric (Flora 2, Divina 3, Divina Melange 2, Hallingdal 65, Tonus 3, Topas 2). BS5852-1 Sch. 4 Part1: Fabric (Pro 2).  
**USA Technical Bulletin 117:** Fabric. Faux leather.



Art.0253 and 0253BV

**CHROMED/PAINTED:**  
 EN 1022/05

EN 1728/2000 - EN 15373:2007 6.2.1 3°  
 EN 1728/2000 - EN 15373:2007 6.2.2 3°  
 EN 1728/2000 - EN 15373:2007 6.7 3°  
 EN 1728/2000 - EN 15373:2007 6.12 3°  
 EN 1728/2000 - EN 15373:2007 6.15 3°  
 EN 1728/2000 - EN 15373:2007 6.16 3°  
**INOX:**  
 EN 1728/2000 - EN 15373:2007 6.2.1 3°  
 EN 1728/2000 - EN 15373:2007 6.2.2 3°  
 EN 1728/2000 - EN 15373:2007 6.7 3°  
 EN 1728/2000 - EN 15373:2007 6.8 3°

**UK DOMESTIC:**  
 BS5852/90 Sez.5 cigarette match



Art.0351 and 0351BV

**CHROMED/PAINTED:**  
 EN 1022/05

EN 1728/2000 - EN 15373:2007 6.2.1 3°  
 EN 1728/2000 - EN 15373:2007 6.2.2 3°  
 EN 1728/2000 - EN 15373:2007 6.7 3°  
 EN 1728/2000 - EN 15373:2007 6.8 3°  
 EN 1728/2000 - EN 15373:2007 6.12 3°  
 EN 1728/2000 - EN 15373:2007 6.15 3°  
 EN 1728/2000 - EN 15373:2007 6.16 3°

**UK CONTRACT:**  
 BS7176-07 Medium Hazard: Fabric (Flora 2, Pro, Tonus 3, Topas 2, Hallingdal 65). Elmosoft, Faux leather. BS7176-07 Low Hazard: Soft leather. Faux leather. Fabric (Orange 2, Divina 3, Divina Melange 2).

**UK DOMESTIC:**  
 BS5852-1 Sch.4-5 Part1: Faux leather. Soft leather, Elmosoft. Fabric (Flora 2, Divina 3, Divina Melange 2, Hallingdal 65, Tonus 3, Topas 2). BS5852-1 Sch. 4 Part1: Fabric (Pro 2).  
**USA Technical Bulletin 117:** Fabric. Faux leather.



Art.0458 and 0458BV

**CHROMED/PAINTED:**

EN 1728/2000 6.12 3°  
 EN 1728/2000 6.13 4°  
 EN 1728/2000 - EN 15373:2007 6.7 3°  
 EN 1728/2000 - EN 15373:2007 6.12 3°

**UK CONTRACT:**  
 BS7176-07 Medium Hazard: Fabric (Flora 2, Pro, Tonus 3, Topas 2, Hallingdal 65). Elmosoft, Faux leather. BS7176-07 Low Hazard: Soft leather. Faux leather. Fabric (Orange 2, Divina 3, Divina Melange 2).

**UK DOMESTIC:**  
 BS5852-1 Sch.4-5 Part1: Faux leather. Soft leather, Elmosoft. Fabric (Flora 2, Divina 3, Divina Melange 2, Hallingdal 65, Tonus 3, Topas 2). BS5852-1 Sch. 4 Part1: Fabric (Pro 2).  
**USA Technical Bulletin 117:** Fabric. Faux leather.



Art.0450 and 0450BV

**CHROMED/PAINTED:**

ANSI-BIFMA X5.1-2002 11  
 ANSI-BIFMA X5.1-2002 16  
 ANSI-BIFMA X5.1-2002 6  
 EN 1022/05  
 EN 1728/2000 - EN 15373:2007 6.2.1 3°  
 EN 1728/2000 - EN 15373:2007 6.2.2 3°  
 EN 1728/2000 - EN 15373:2007 6.7 3°  
 EN 1728/2000 - EN 15373:2007 6.12 3°  
 EN 1728/2000 - EN 15373:2007 6.15 3°  
 EN 1728/2000 - EN 15373:2007 6.16 3°  
**INOX:**  
 EN 1728/2000 - EN 15373:2007 6.2.1 3°  
 EN 1728/2000 - EN 15373:2007 6.2.2 3°  
 EN 1728/2000 - EN 15373:2007 6.7 3°  
 EN 1728/2000 - EN 15373:2007 6.8 3°



arper

F +39 0422 791800

www.arper.com T +39 0422 7918

\* For more information on product's certification and environment documents visit [www.arper.com](http://www.arper.com) or contact us at [environment@arper.com](mailto:environment@arper.com)

# Catifa 46 / 4 Legs

## Design by Lievore Altherr Molina, 2004

### Fire retardant test

### Resistance test



UK CONTRACT:  
BS7176-07 Medium Hazard: Fabric (Flora 2, Pro, Tonus 3, Topas 2, Hallingdal 65). Elmosoft, Faux leather. BS7176-07 Low Hazard: Soft leather.  
Faux leather. Fabric (Orange 2, Divina 3, Divina Melange 2).  
UK DOMESTIC:  
BS5852-1 Sch.4-5 Part1: Faux leather. Soft leather, Elmosoft. Fabric (Flora 2, Divina 3, Divina Melange 2, Hallingdal 65, Tonus 3, Topas 2). BS5852-1 Sch. 4 Part1: Fabric (Pro 2).  
USA Technical Bulletin 117: Fabric. Faux leather.

Art.0310 and 0310BV

CHROMED/PAINTED:  
EN 1022/05

EN 1728/2000 - EN 15373:2007	6.2.1	3°
EN 1728/2000 - EN 15373:2007	6.2.2	3°
EN 1728/2000 - EN 15373:2007	6.7	3°
EN 1728/2000 - EN 15373:2007	6.12	3°
EN 1728/2000 - EN 15373:2007	6.15	3°
EN 1728/2000 - EN 15373:2007	6.16	3°
INOX:		
EN 1728/2000 - EN 15373:2007	6.2.1	3°
EN 1728/2000 - EN 15373:2007	6.2.2	3°
EN 1728/2000 - EN 15373:2007	6.7	3°
EN 1728/2000 - EN 15373:2007	6.8	3°



arper

F +39 0422 791800

T +39 0422 7918

www.arper.com

\* For more information on product's certification and environment documents visit [www.arper.com](http://www.arper.com) or contact us at [environment@arper.com](mailto:environment@arper.com)